

ICNS 2009

**A viewpoint on the Management of the
Future Internet**

Joan Serrat

Universitat Politècnica de Catalunya

Internet today

- The Internet has become the dominating communications platform for various reason including convergence and cost optimization
- Already today, and even more so tomorrow, it carries services which are critical for the world's economy and the society as a whole
 - Everyday communications (Telephony, Email), TV, Information (Google, Wikipedia etc.), social life (Facebook and other social networks) and more
 - Transport of mission critical data between e.g. banks or stock exchanges
 - E-commerce for both businesses and individuals from Salesforce to Amazon

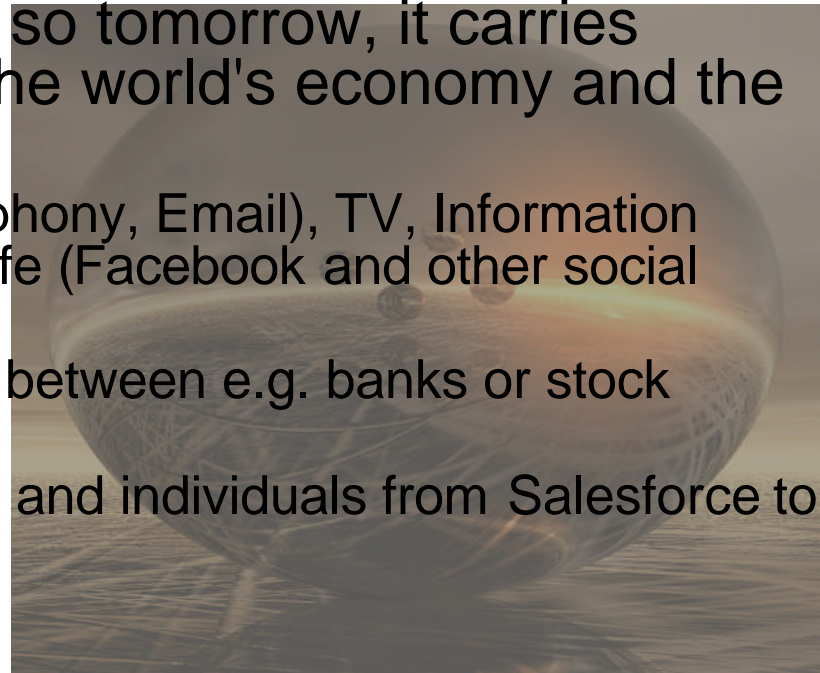

Which are the limitations of the current Internet to face mean term and future expectations ?

Requirement: Deployment of new protocols

- **Current Internet limitation addressed**
 - Predetermined protocol stack
- Trends
 - Virtualization of network nodes
- Challenges
 - Efficiency, monitoring and programmability of VRs

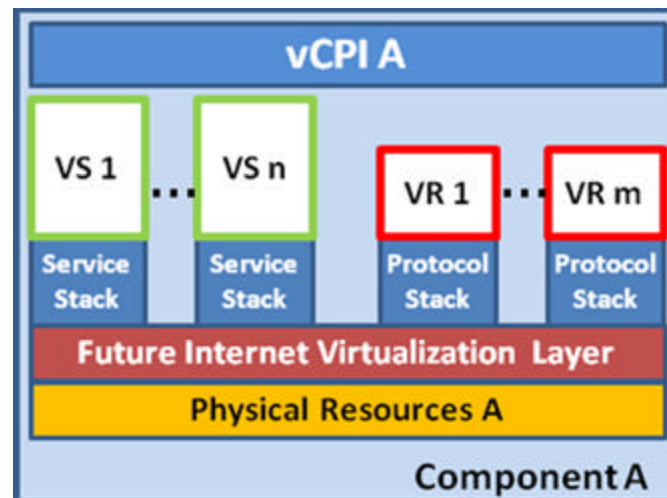

Requirement: Cooperation and mobility of networks

- **Current Internet limitation addressed**
 - Lack of mobility experience of the user
- Trends
 - Look for more advanced (self)management systems
- Challenges
 - Scalability, security (trust)

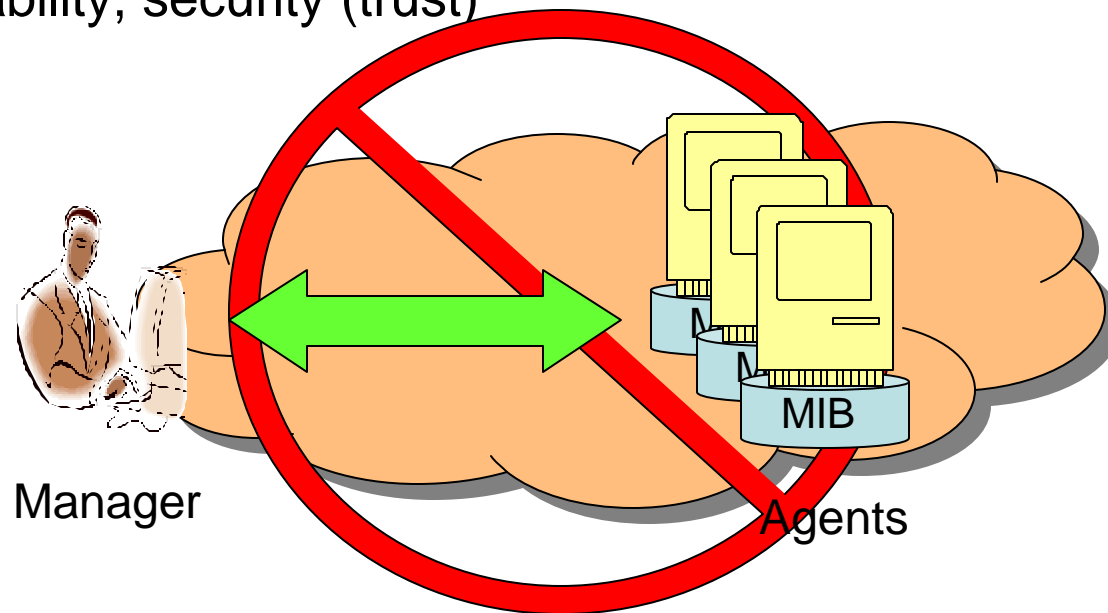

Requirement : Future Internet Services support

- **Current Internet limitation addressed**
 - The network is unaware of the services it supports
- Trends
 - Service-driven network management
- Challenges
 - Refinement of service goals into network configuration commands

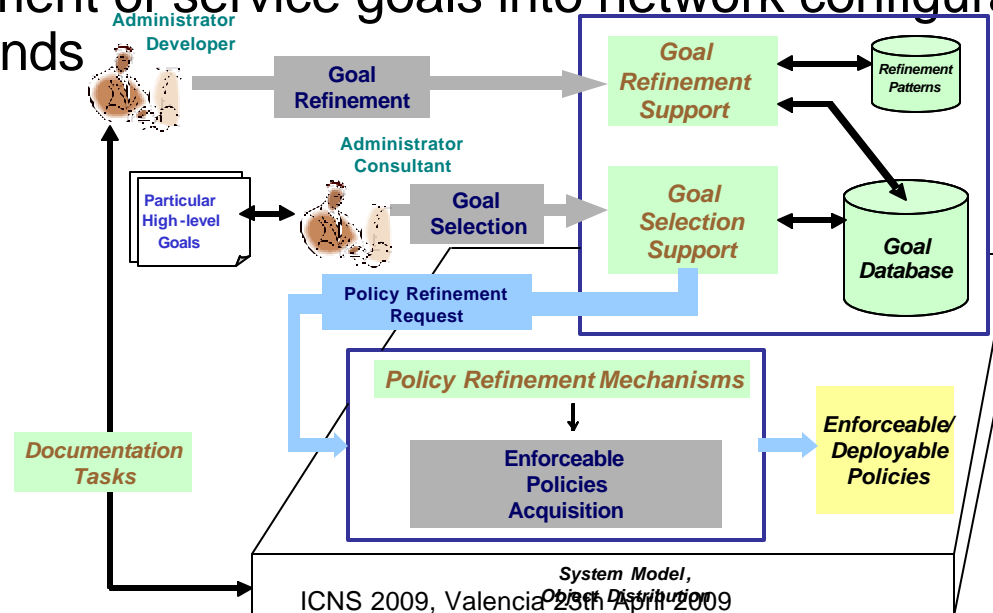

Requirement : Deployment of consistent policies

- **Current Internet limitation addressed**
 - Disconnection between Internet governing policies at different levels
- Trends
 - Work with the concept of a “continuum of policies” (interrelated policies)

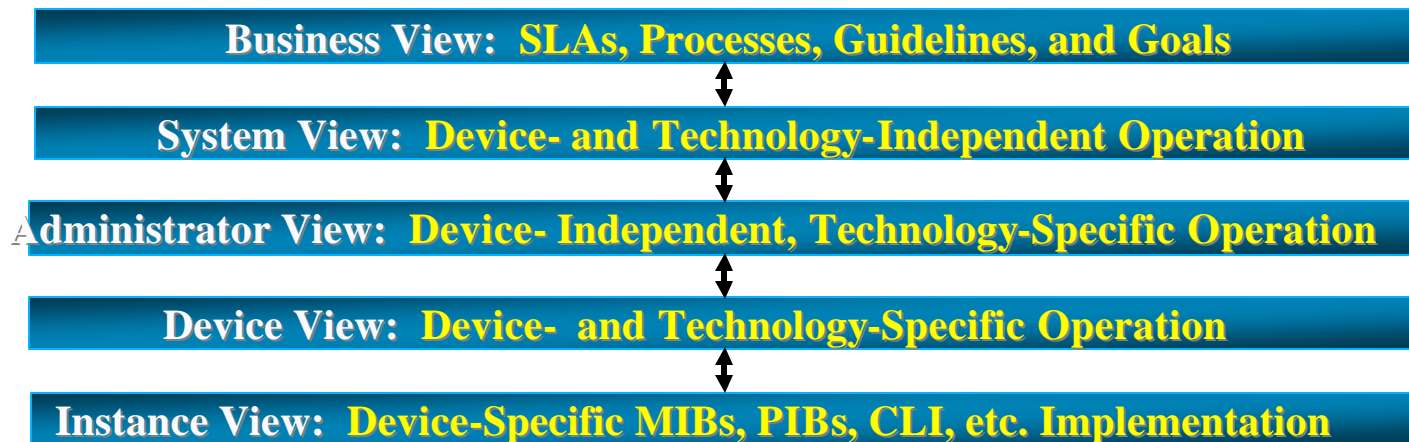

Requirement : Service coalitions

- **Current Internet limitation addressed**
 - Interaction between different domains is predetermined or requires tedious manual negotiations
- Trends
 - Allow and define dynamic negotiation processes and mechanisms between domains
- Challenges
 - Efficient and robust algorithms needed

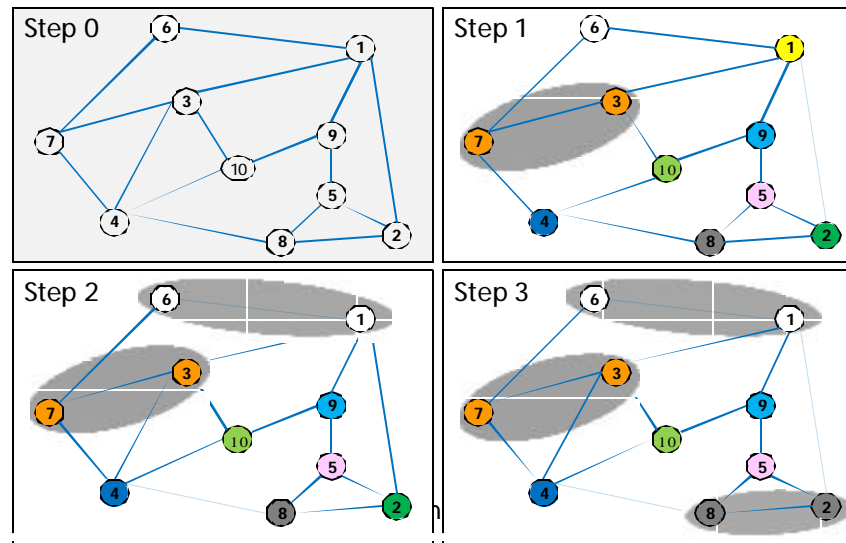

Near-term expected services

- Example: ubiquitous multimedia streaming service

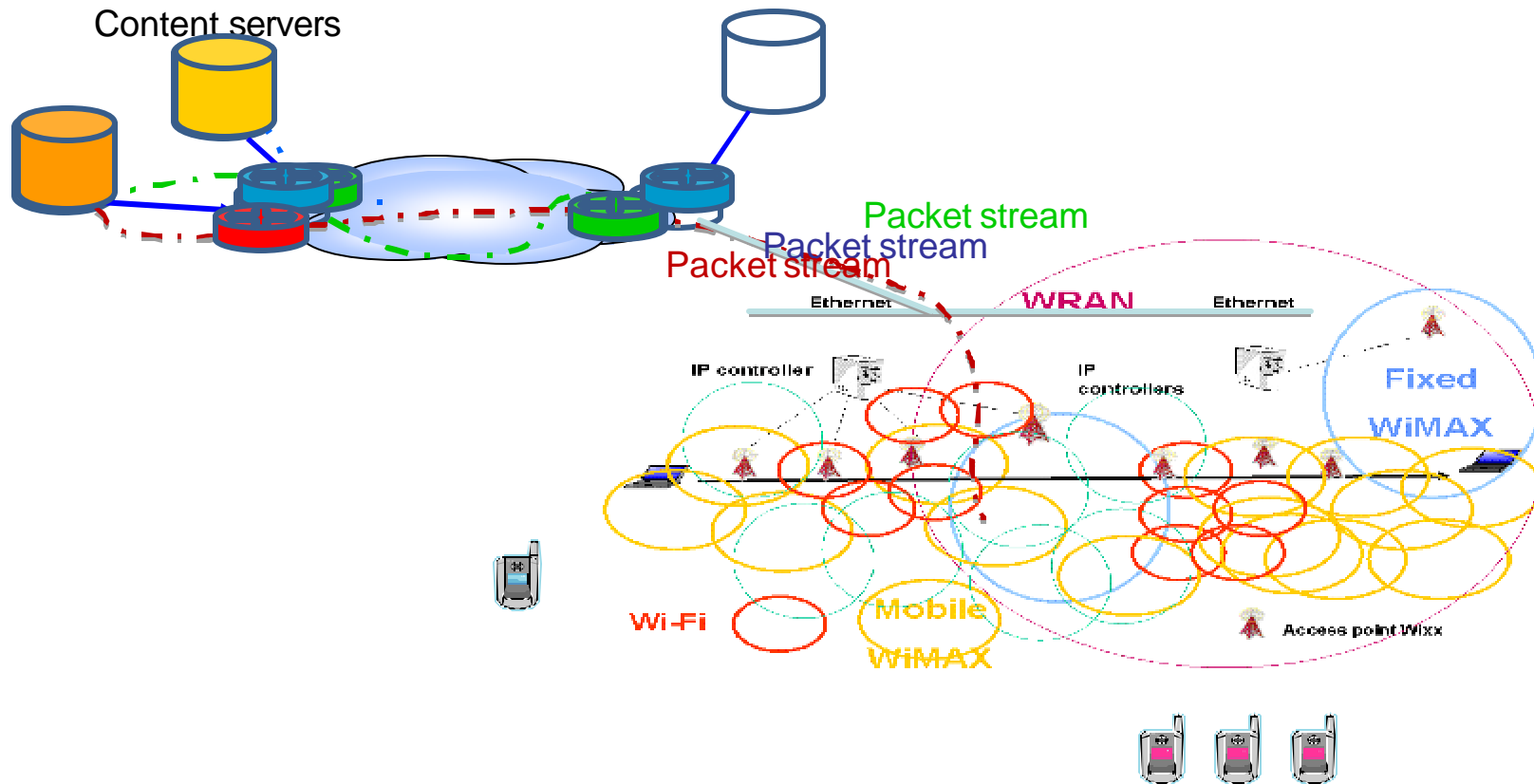

... we rely on the Internet and we expect more and more

- The question is:

- *is the road smooth and clear?*

or

- *are there threads to the Internet which might jeopardize this evolution?*

Scenario 1: Sudden Meltdown

- Current threads
 - Too many open backdoors to control the IP infrastructure
 - Easy to implement threads: DDoS, trojans, etc.
 - Accidental misconfiguration
 - Pakistan's accidental hijacking of YouTube
 - Economic and political quarrels
 - Peering wars
- Attacks on critical infrastructure bring everything to a halt
 - E-government services
 - Economic institutions: banks, stock exchanges

Scenario 2: Lack of Investment

- Commoditisation
 - The network infrastructure is becoming a commodity for an ever increasing fraction of society, increasing our reliance on it
- No incentives to invest in upgrading this infrastructure
 - Unfavorable regulatory landscape
 - Any upgrade has to be made available by the incumbents to the rest
 - Restricted possibilities to build a differentiated service offering by innovating the infrastructure
 - Upgrades make no P-R
- An over-aged infrastructure is an obstacle for innovation
 - As with an old car, it will finally break beyond repair
 - Too hard to find replacements
 - Too hard to find the expertise to repair it

Regulatory
Environment

Increasing O/M
costs

Aging
Infrastructure

Scenario 3: Increasing Complexity

- Trying to cater for current and future requirements of the Internet may lead to:
 - A proliferation of coexisting incompatible protocol stacks
 - Deployment of a plethora of ad-hoc solutions to control E2E QoS in mobile ubiquitous environments
 - Emergence of independent sources trying to control the network (like the applications themselves)
 - Deployment of more and more policies without the appropriate mechanisms to have a clear view of the consequences and impact on all the affected resources and supported services
 - Allowing for complex mechanisms between parties involved in service offering
- The attempt to address the ever increasing number of requirements causes the network to become too complex to be properly managed resulting in unpredictable behavior or even collapse

How to face the future

- A New Internet is necessary to tackle the above challenges
 - In particular: an Internet laying on **Autonomic Communications** principles with embedded self-management capabilities

Autonomic Management Principles

- **Aware and Self-aware functions:** It monitors the network and operational context as well as internal operational network state in order to assess if the network current behaviour serve its service purposes.
- **Adaptive and Self-adaptive functions:** It triggers changes in network operations (state, configurations, functions) function of the changes in network context.
- **Automatic self-functions:** It enables self-control (i.e. self-FCAPS, -*) of its internal network operations, functions and state. It also bootstrap itself and it operates without manual external intervention. Only manual/external input is the setting-up of the goal(s).
- **Embedded (In) Network functions:** The entire management functionality should be imbedded in the network.

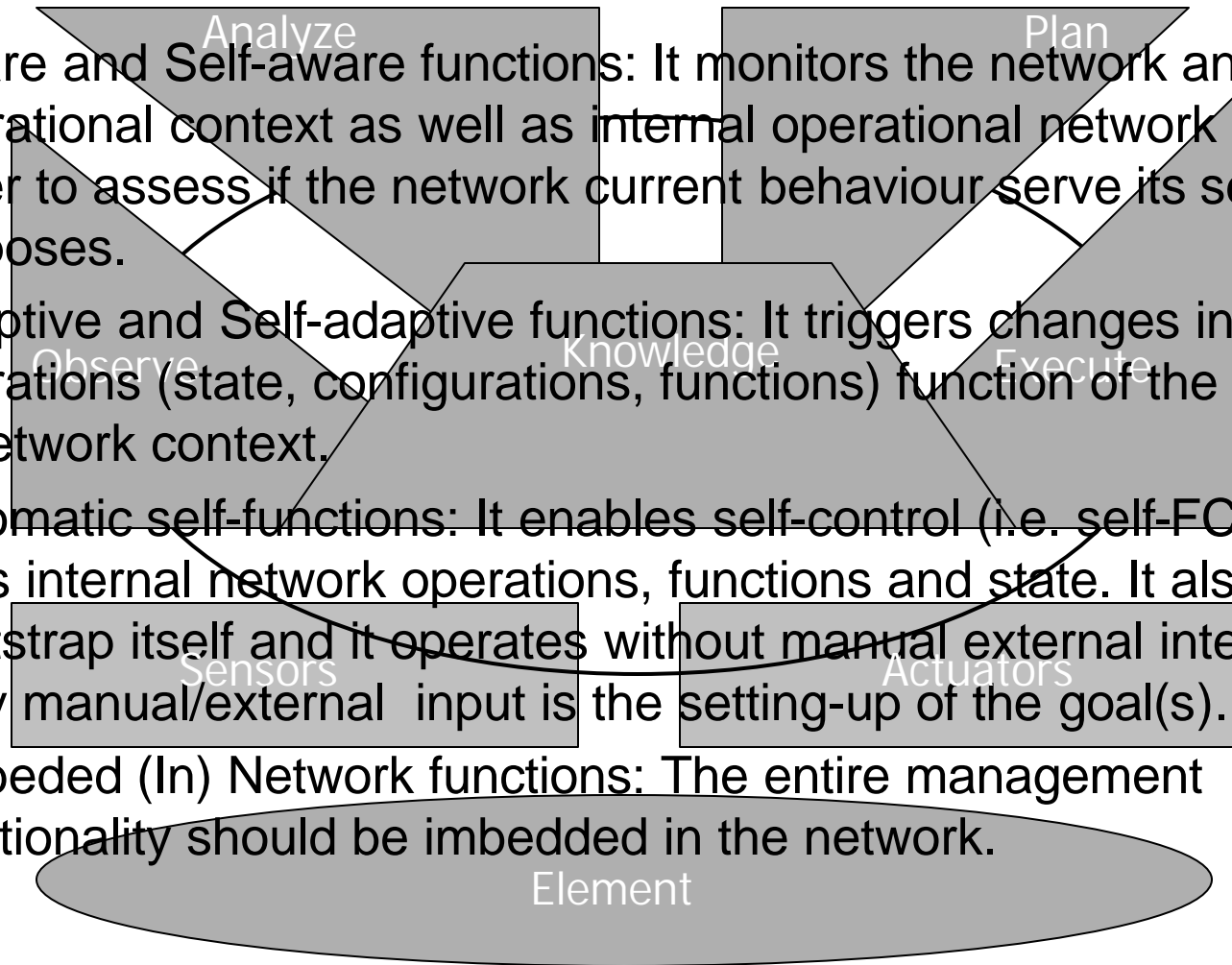

An Autonomic Management Framework approach

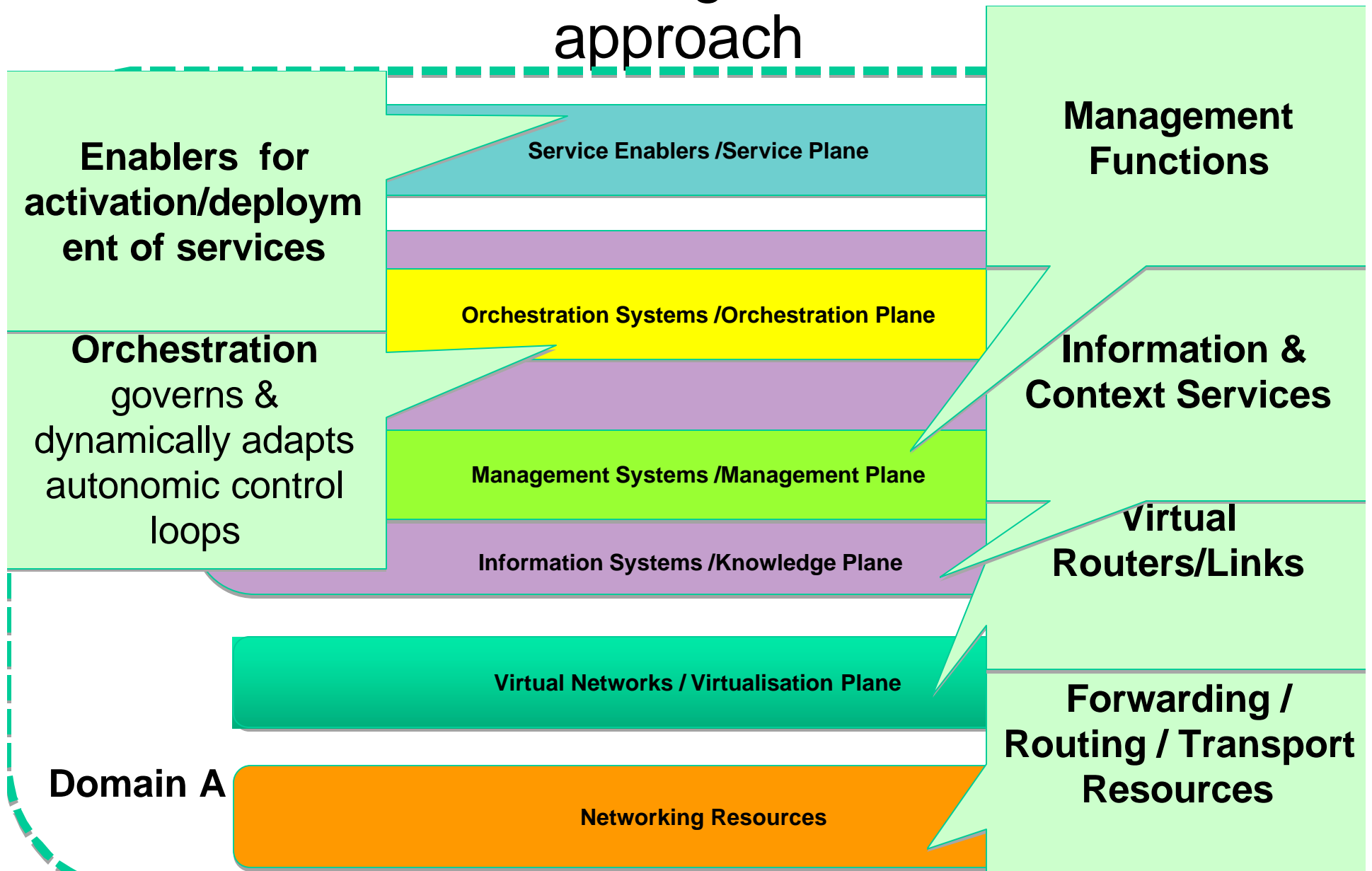

An Autonomic Management Framework approach

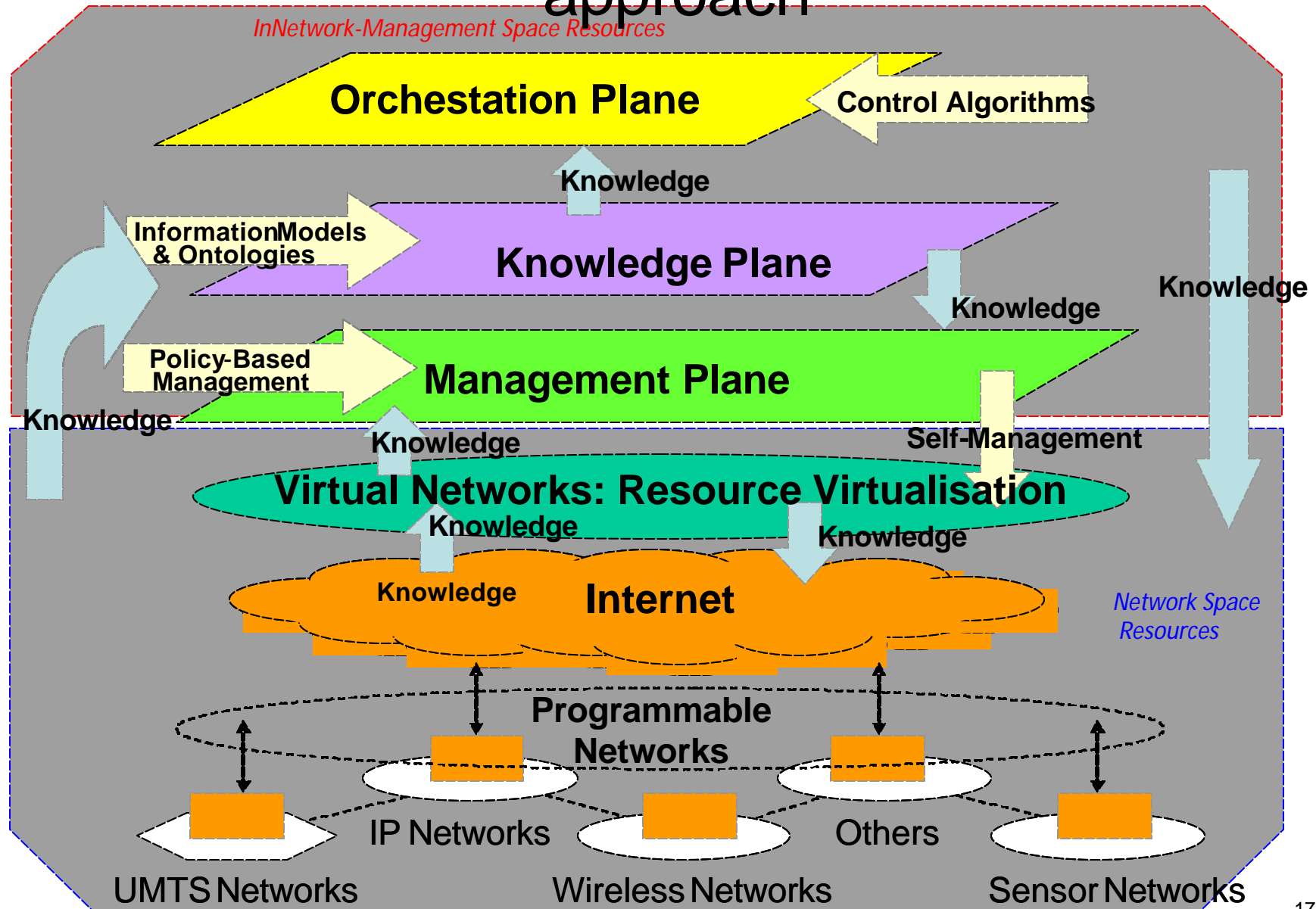

Autonomic Management Framework

Service lifecycle /Startup

Registration in the VP and notification of available resources to the MP and KP

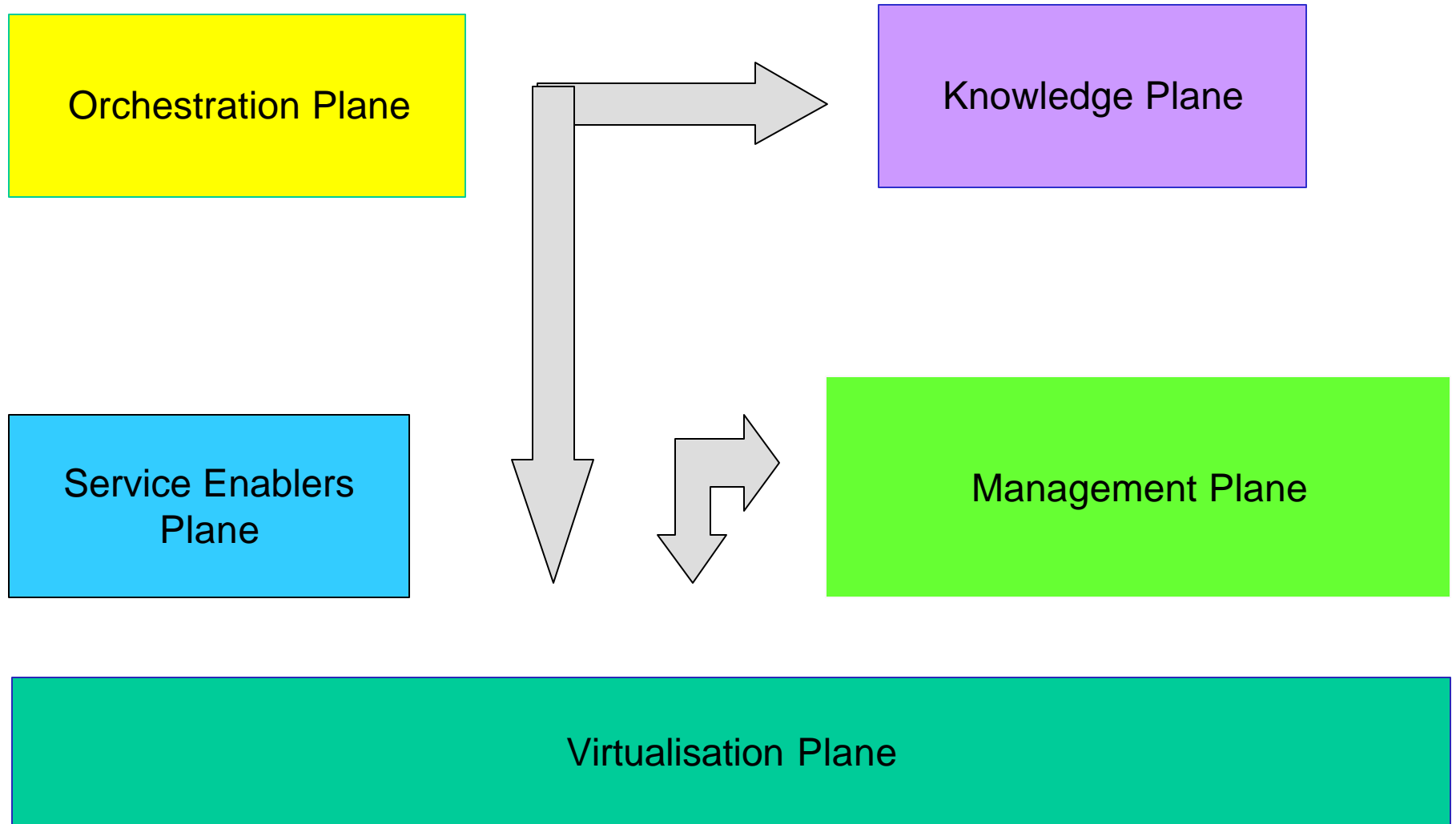

Autonomic Management Framework Service lifecycle /Startup

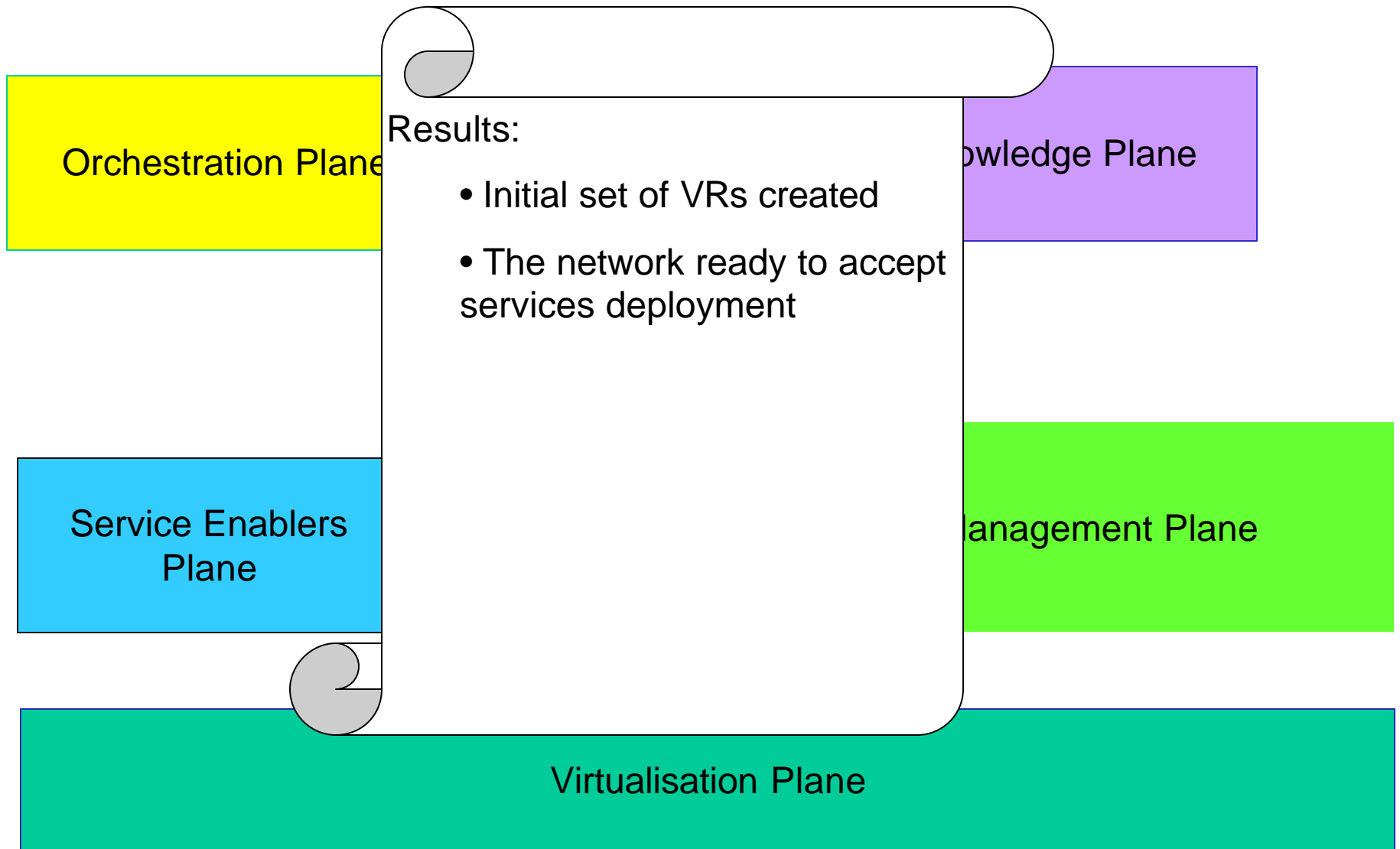

Autonomic Management Framework

Service preconfiguration

Service deployment request

Negotiation, distribution, federation

Define managed virtual resources and instantiate data model

Deploy AMSs, instantiate policies and subscribe to context info

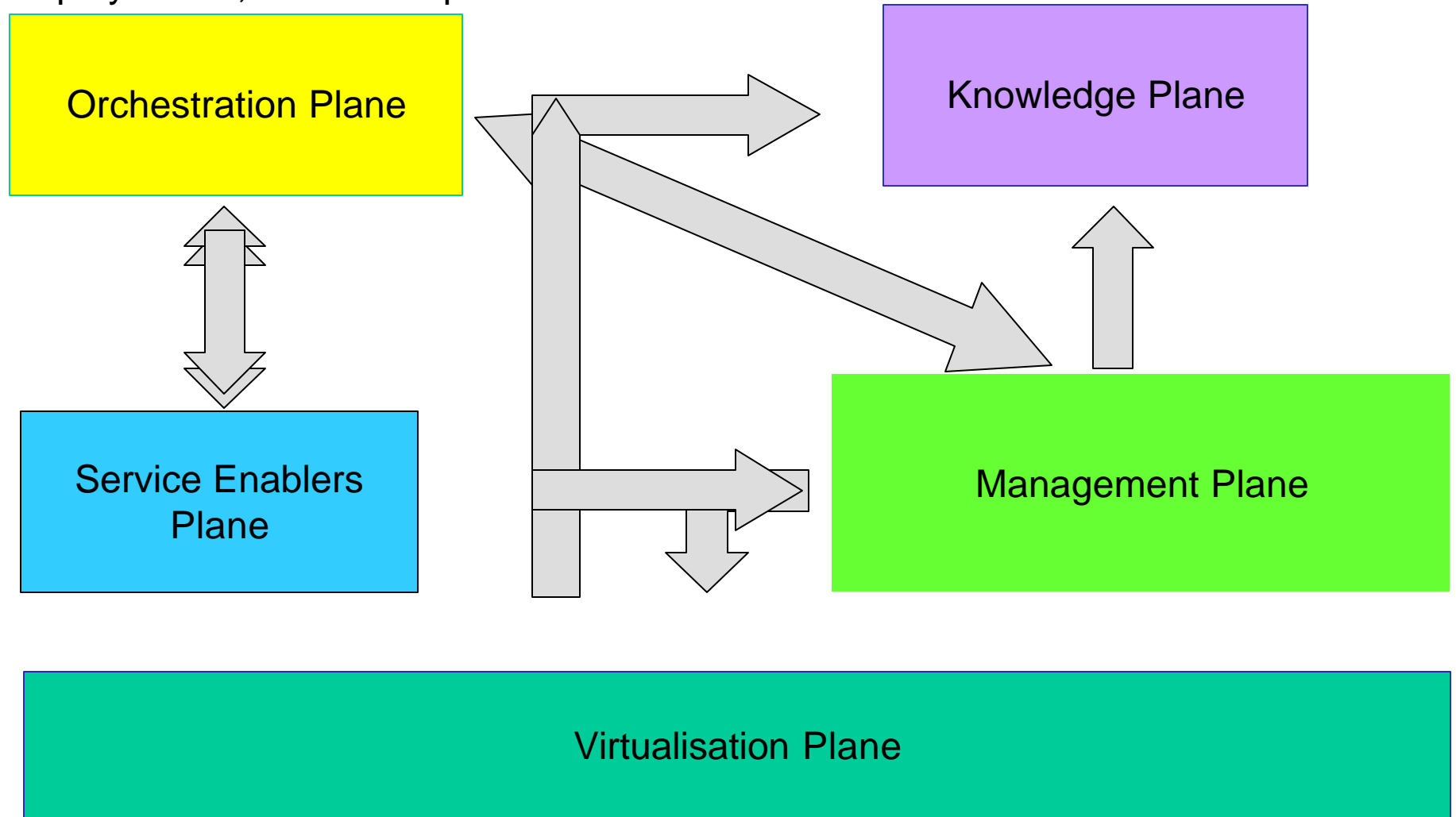

Autonomic Management Framework

Service preconfiguration

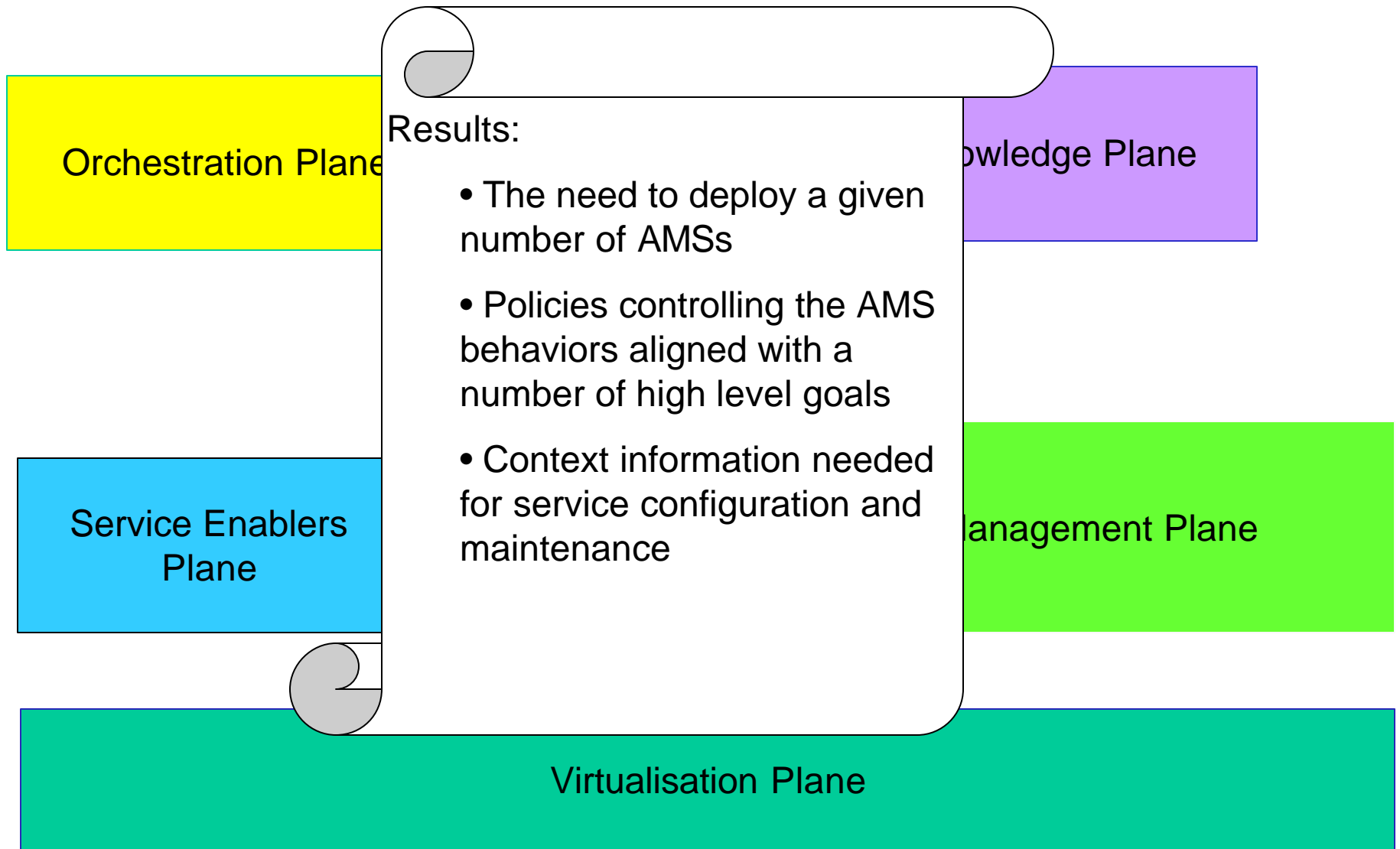

Autonomic Management Framework

Service invocation

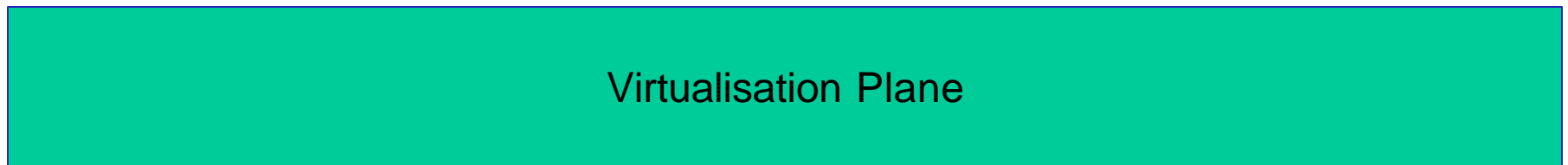
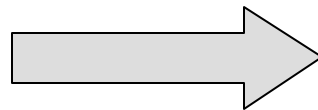
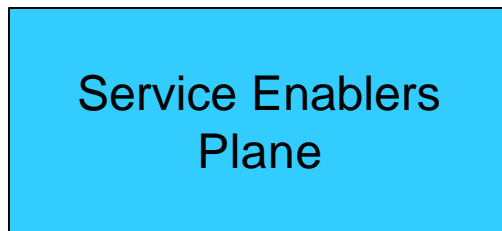
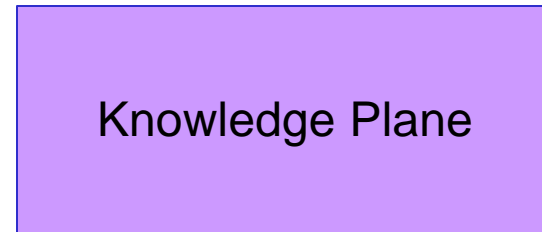
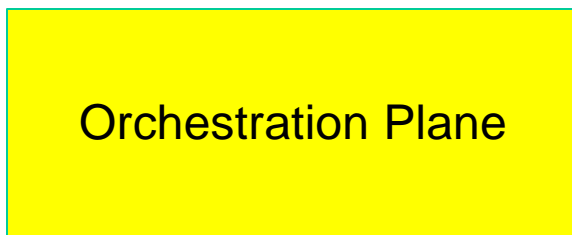

Autonomic Management Framework

Service invocation

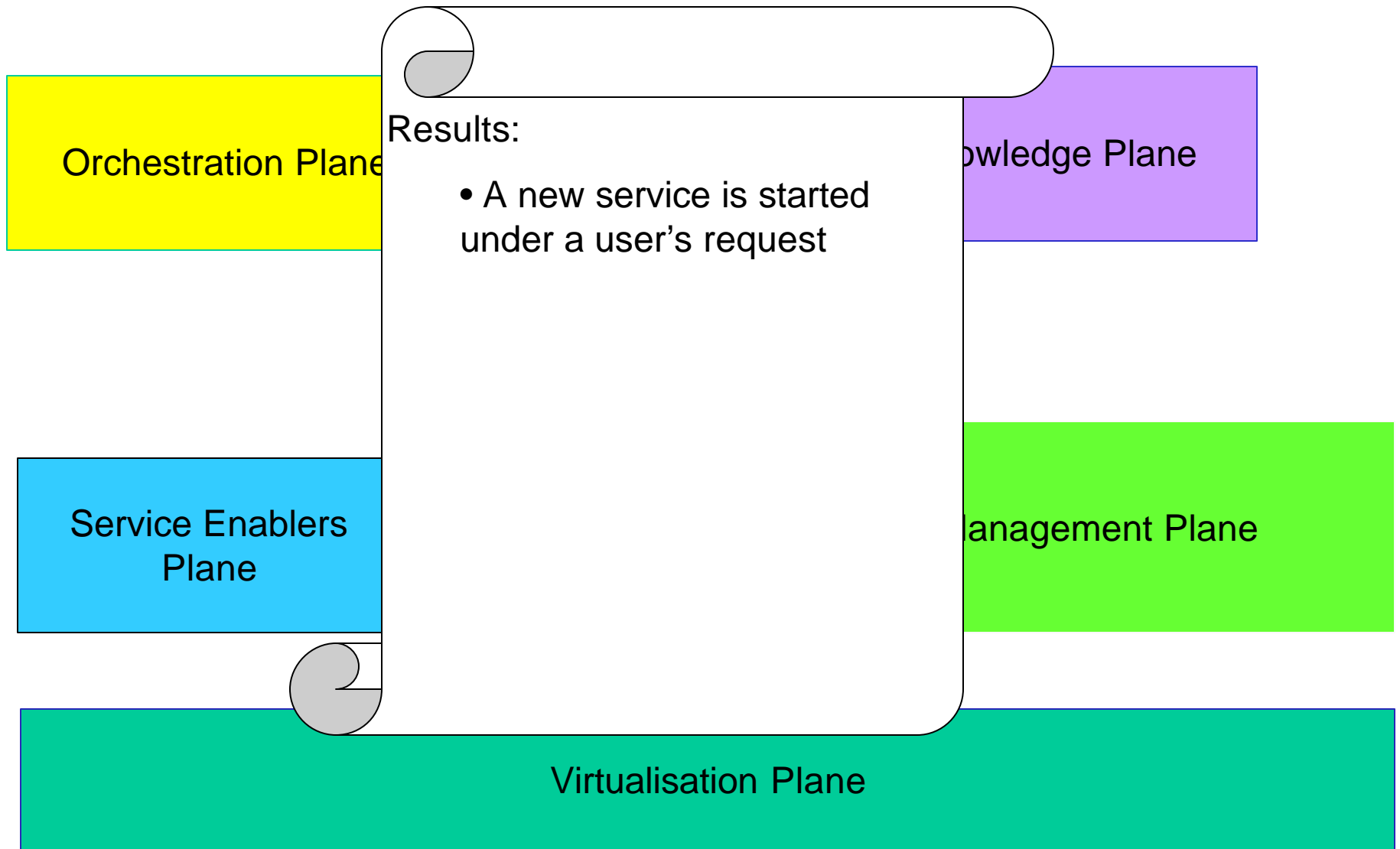

Autonomic Management Framework

Service assurance

Self {F.C.A.P.S} actions

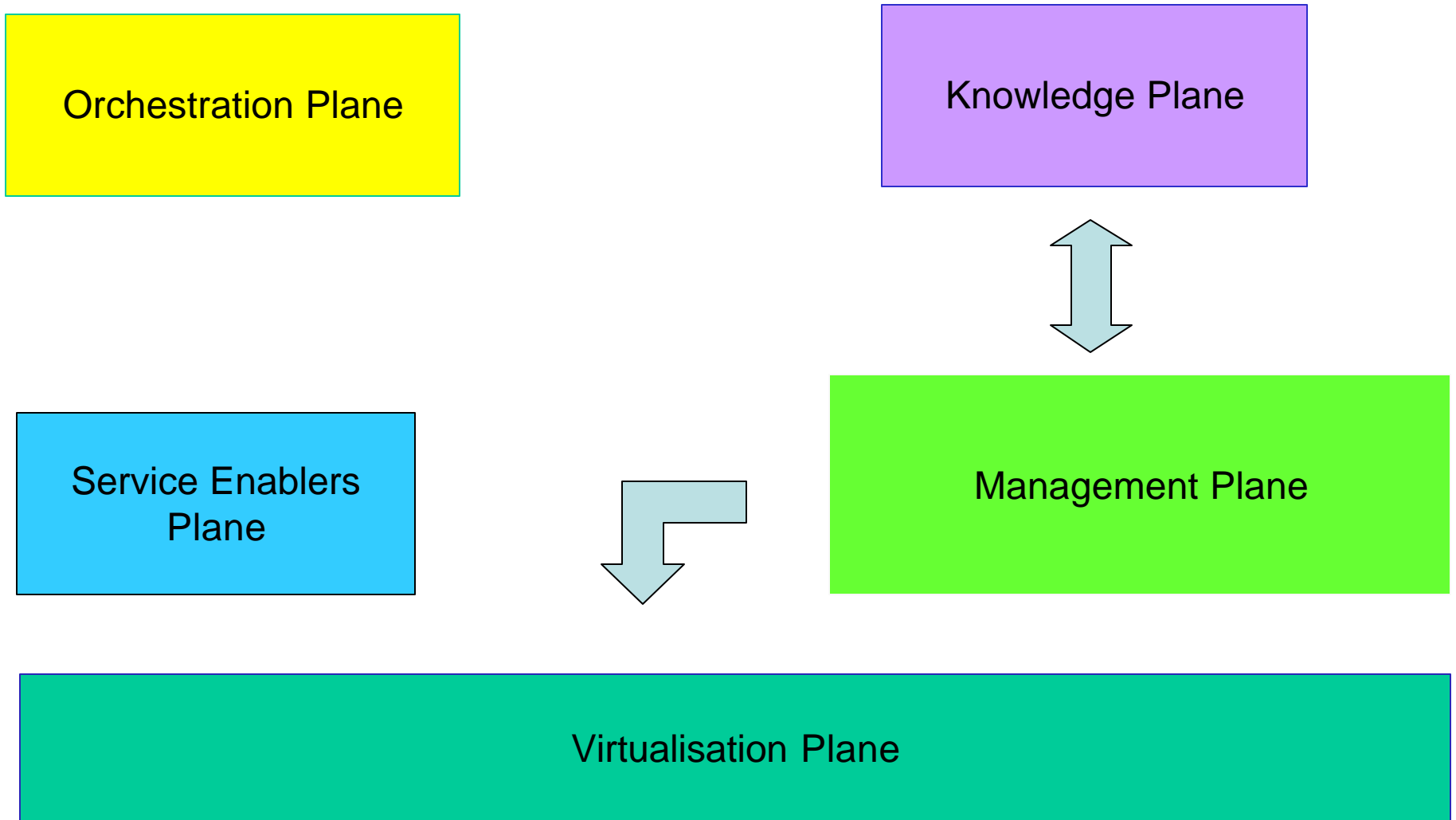

Autonomic Management Framework

Service assurance

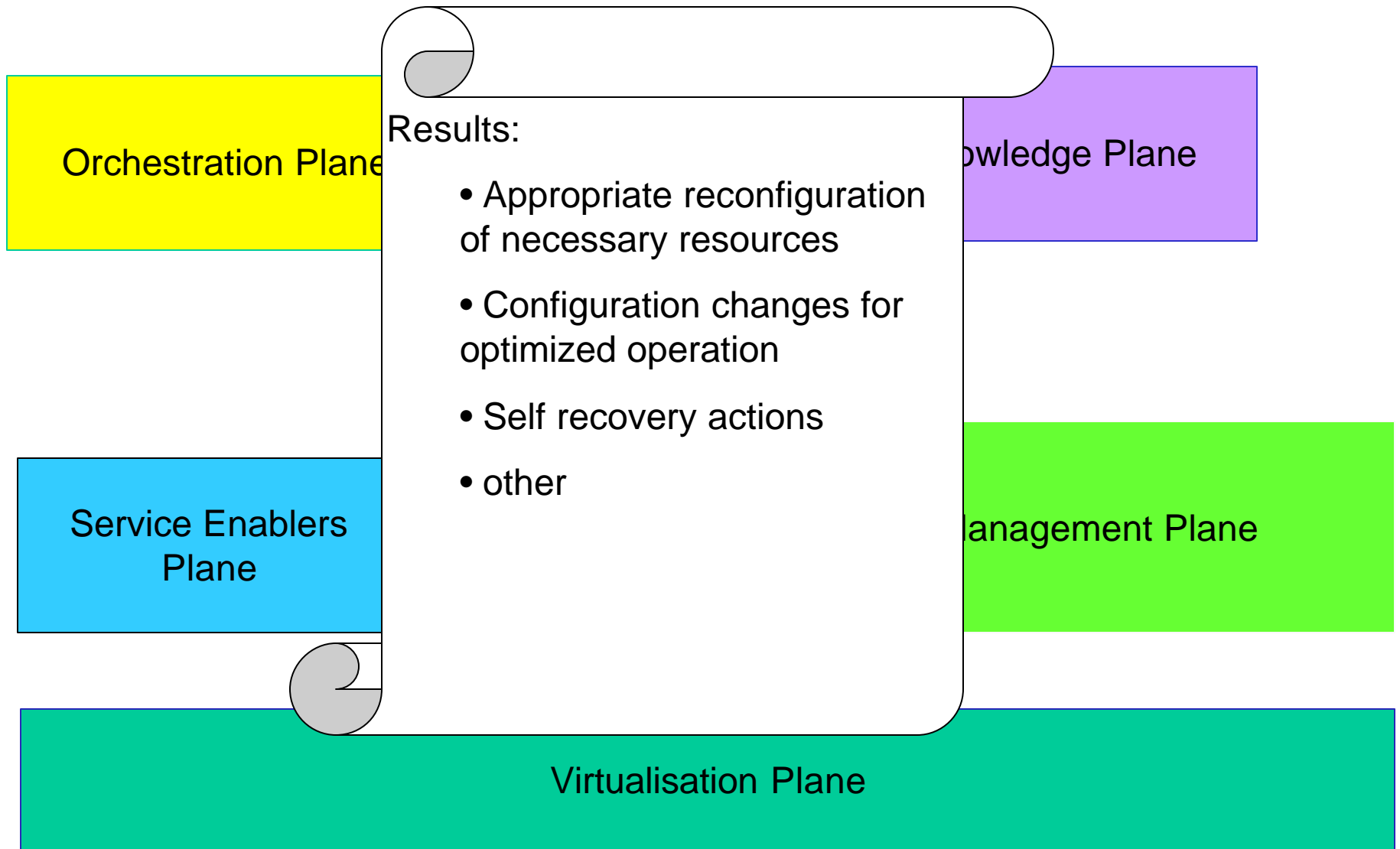

Autonomous Management Systems highlights

Autonomous Management Systems highlights: KP/Managed resources

- Managed resources (fixed network)
 - Exhibit different states

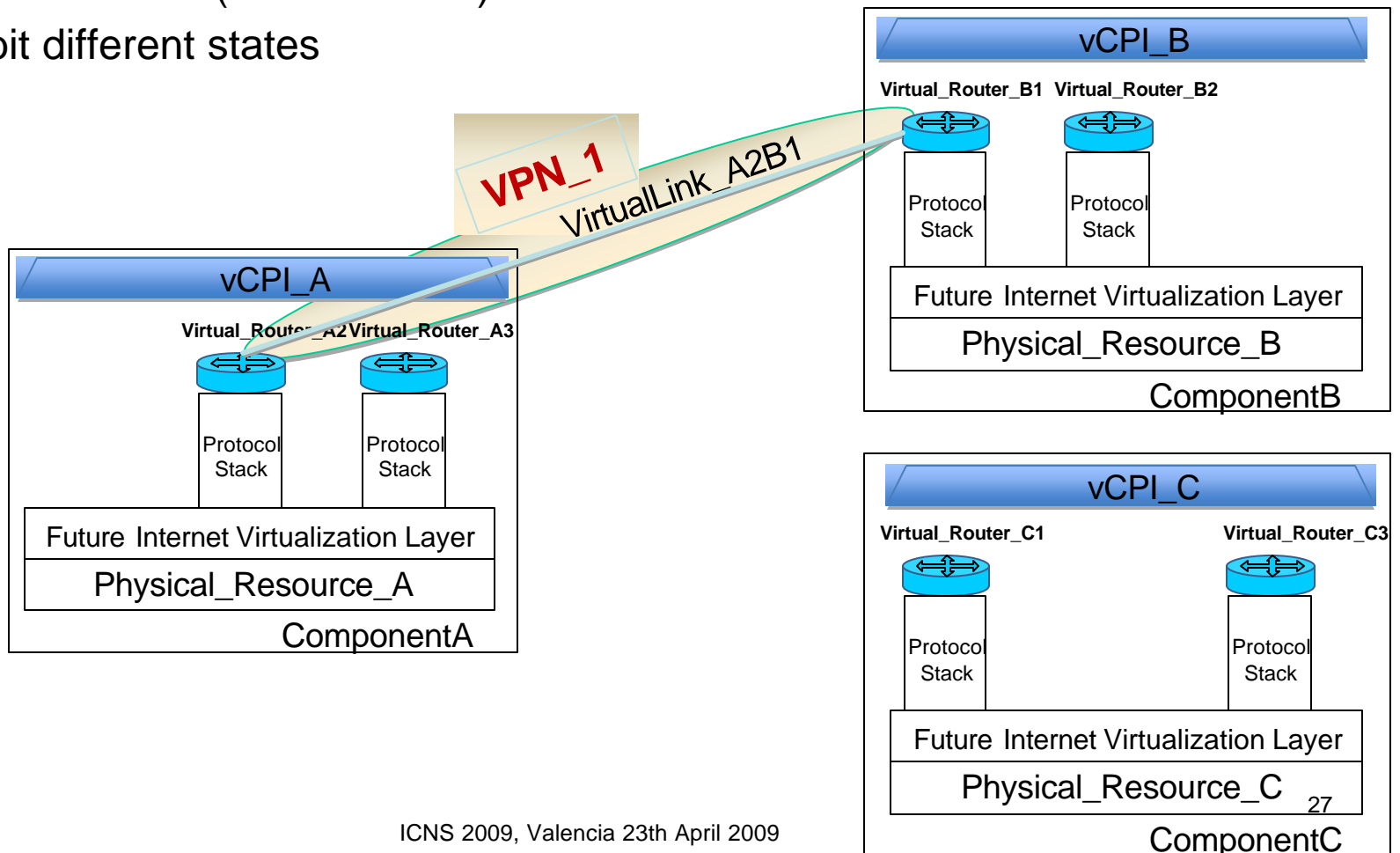

Autonomous Management Systems highlights: KP/Managed resources

- Managed resources (wireless network)
 - Exhibit different states

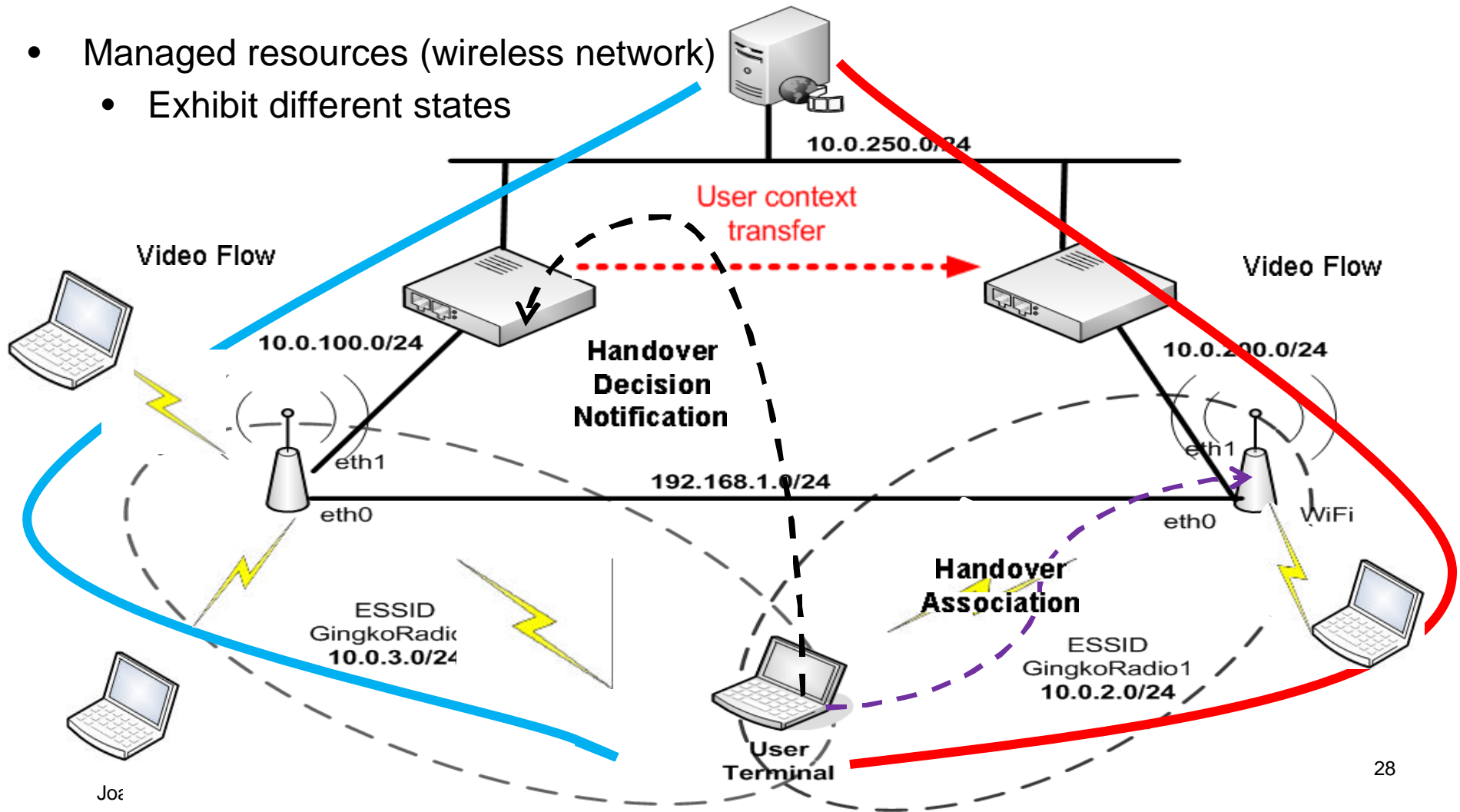

Autonomous Management Systems highlights: Modeling of resources

- Information Models have to capture structure and state of resources

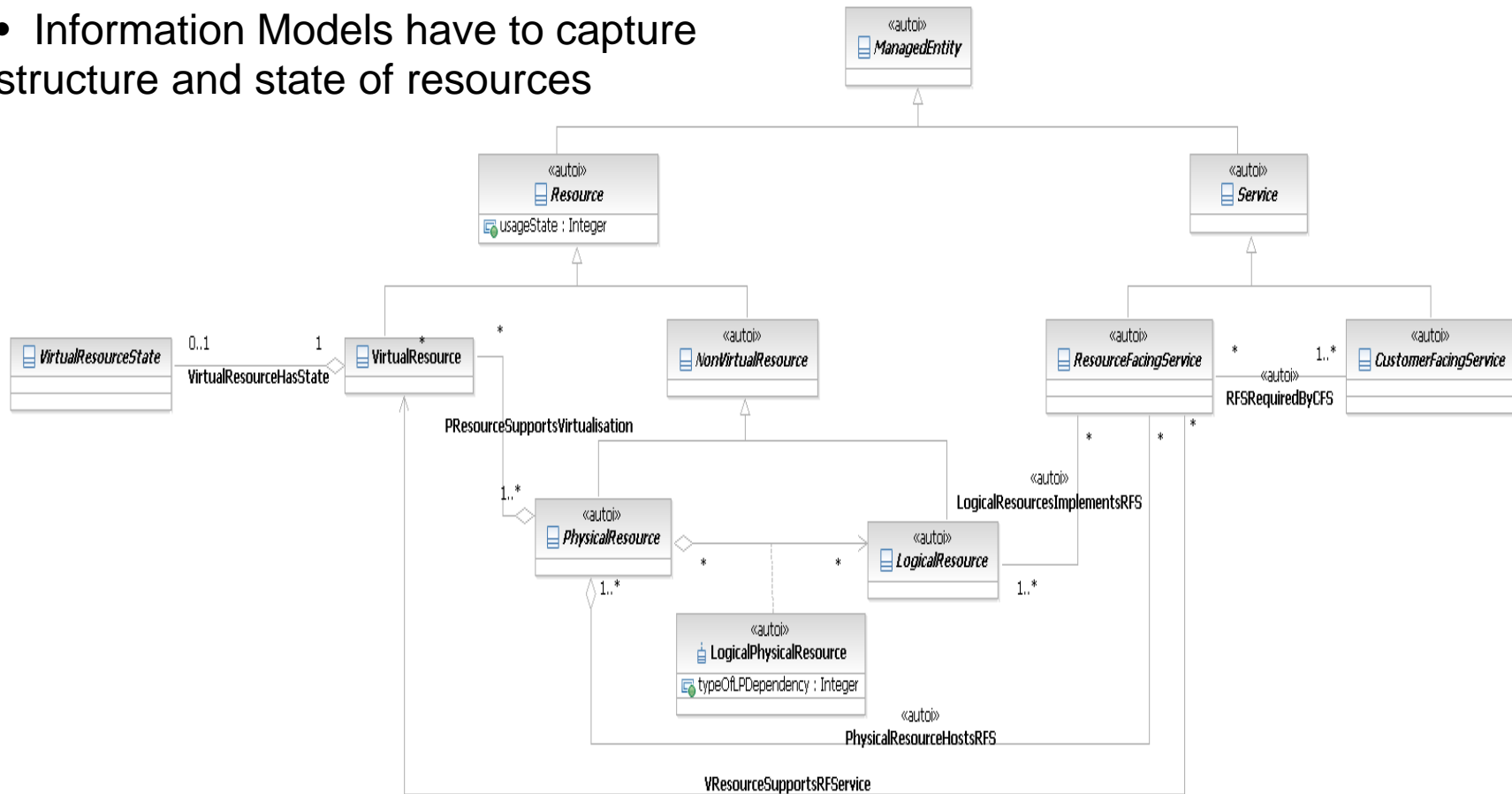

Autonomous Management Systems highlights: Modeling of resources

- State of the Art
 - Common Information Model, CIM (DMTF),
 - Shared Information and Data Model, SID (TMF)
 - Directory Enabled Networks, DEN-ng (ACF)

advantages /disadvantages can be argued, but

- The model must be augmented with ontologies to support:
 - Mapping between layers of the policy continuum
 - Effective grouping of context information and reasoning over it to infer new information and reason to enable decisions
 - Mapping between service specifications and resource availability
 - To support the system in sending one set of commands to multiple heterogeneous devices

Autonomous Management Systems highlights: The role of AMSs

- The AMS is entrusted to control the state of managed resources in its management domain
- Interacts with managed resources through appropriate interfaces (i.e. the vCPI in the virtual routers)

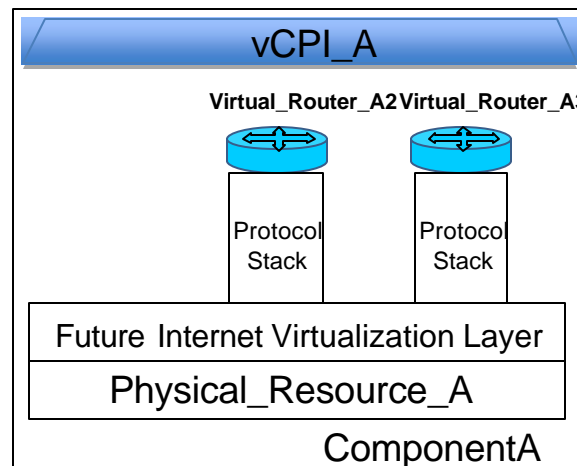

Autonomous Management Systems

highlights: How the AMS works

- The AMS compares the “current state” of the managed resource with the “target state”
 - Current state: derived from the resource context. A semantic translator can be required to interpret the state from rough context info
 - Target state: known at service preconfiguration time through policies

Autonomous Management Systems highlights: AMS functional architecture

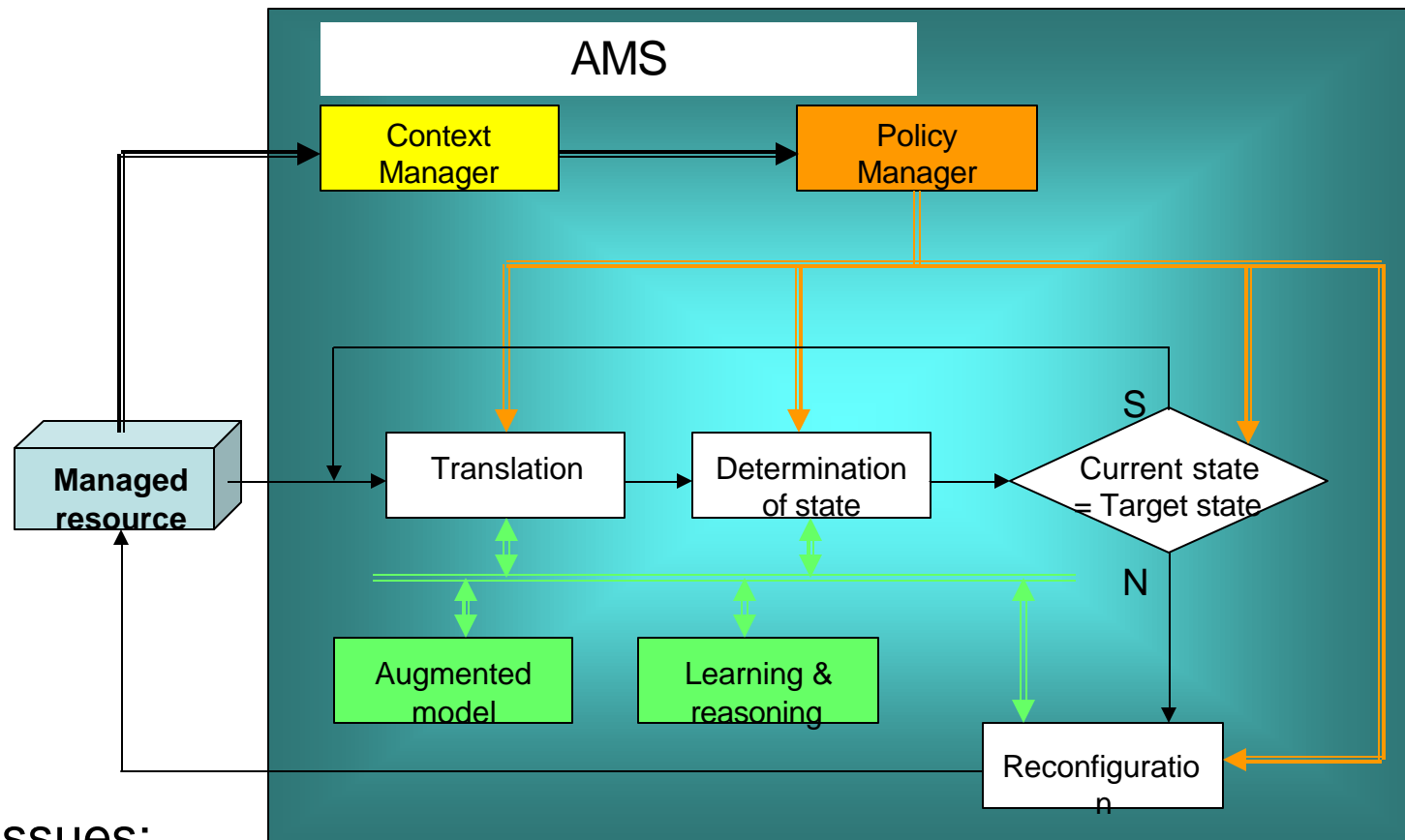

- Issues:
 - Scalability & stability of control loops?

Autonomous Management Systems highlights: AMS Reasoning and Learning capabilities

- Reasoning:
 - By means of ontologies allowing for:
 - The AMS recognizes the environment where it is being deployed (fixed network, mobile etc,)
 - The AMS is able to instantiate its governance policies
 - By means of other techniques
- Learning:
 - Reinforced learning techniques
 - To modify the target state policies
 - To modify other policies
 - Other learning techniques

Orchestration Components highlights

Orchestration Components highlights: Functions and Requirements

- Functions
 - Negotiate and solve conflicts between self-governing AMSs
 - Distribute services (management and end-user) in the network
 - Federate / unfederate domains
 - Define high-level goals to AMSs, orchestrating the operation of the network
 - Control the workflow of the interaction, creation and destruction of AMSs
- Requirements
 - Should act based on high-level (i.e. business) goals
 - Should rely on open protocols and standardized information models
 - Should be extensible, (un)plug/play of components to accommodate new requirements and technologies
 - Should reach a compromise for domains with different SLAs, security policies and technologies

Orchestration Components highlights: Architecture

- The OP is composed of Distributed Orchestration Components (DOCs)
- Components of the DOCs:
 - The Dynamic Planner is a policy- based scheduler of Behaviors
 - Behaviours implement orchestration functions and interface for DOC/AMS interactions

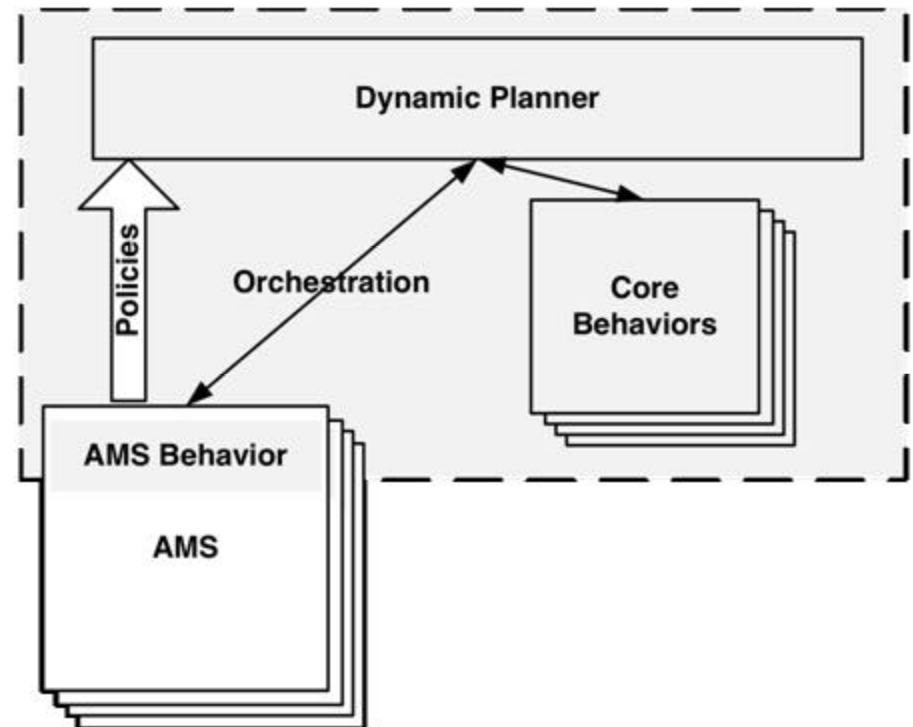

Orchestration Component highlights: Architecture

- Dynamic Planner:
 - Policies define the order and which Behaviors to be bootstrapped
 - Bridges requests from AMSs to the corresponding Behaviors
- Behaviours:
 - Core Behaviors implement internal functions, i.e. federation, negotiation, distribution, creation/destruction of AMSs, update of knowledge in the KP
 - AMS Behaviors marshal AMS calls into the DOC's vocabulary

Conclusions

Shift in Network Management Paradigm

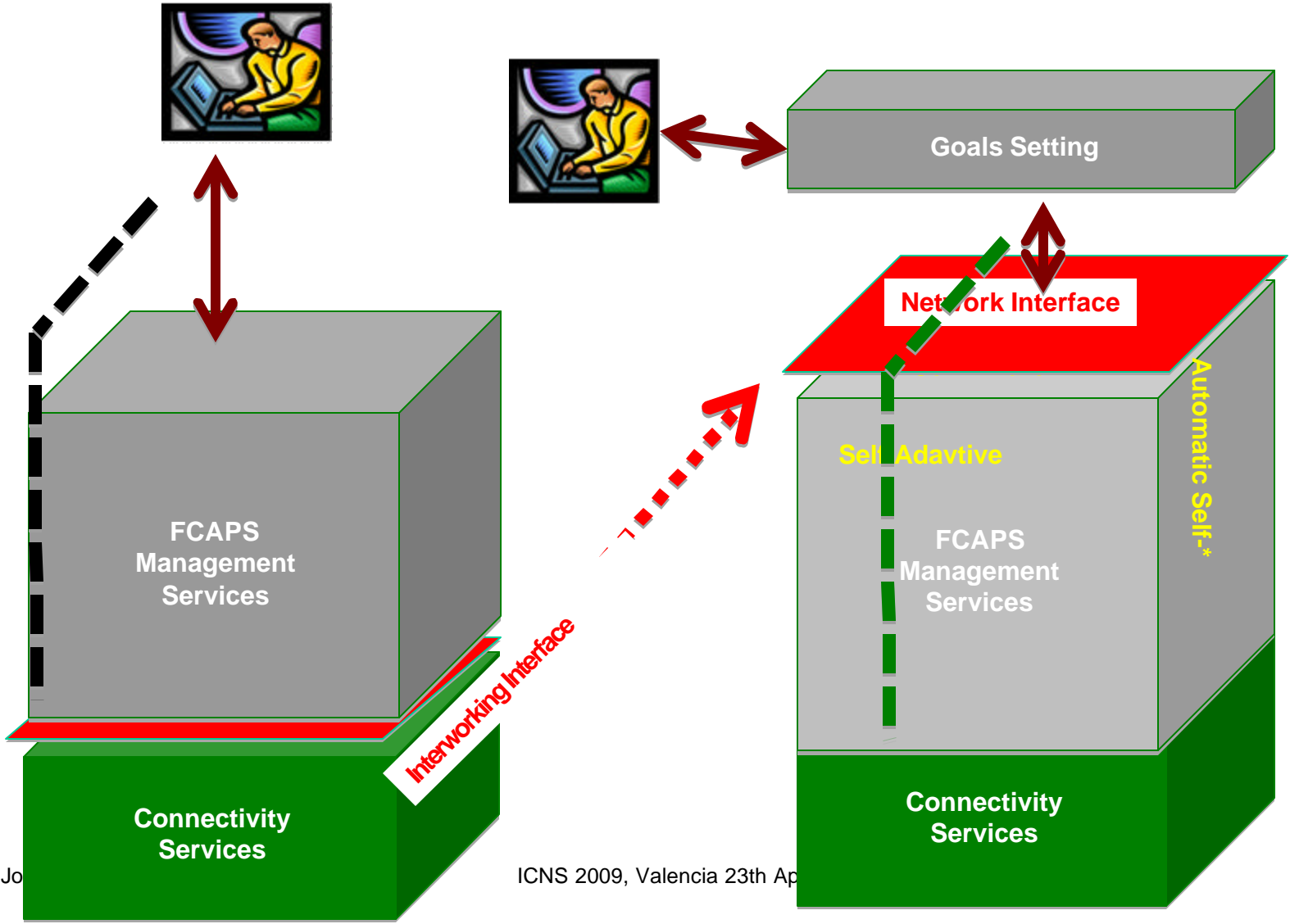

FI2020 - Architectural View

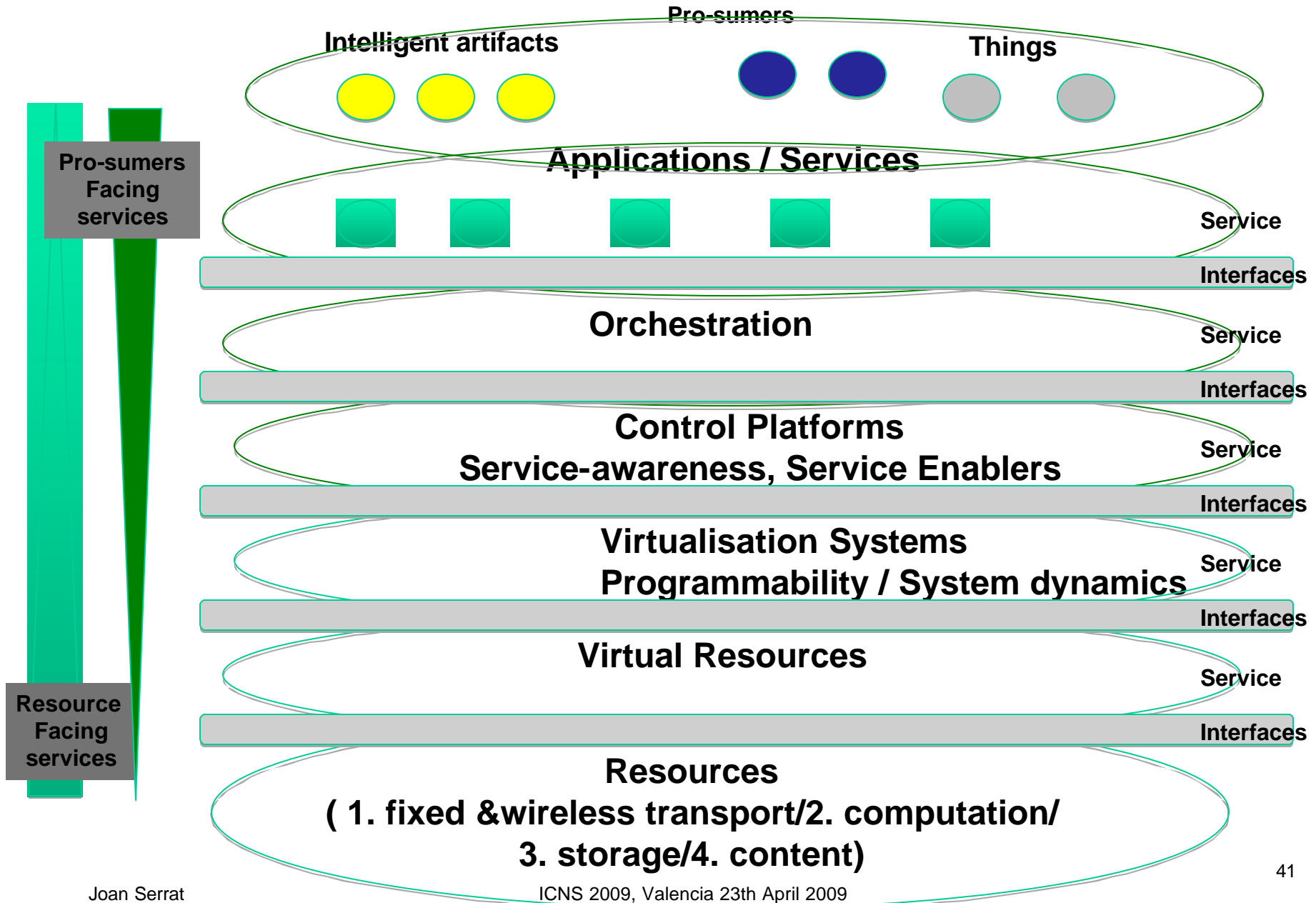

Acknowledgements

- To my colleagues of
 - Autonomic Internet project (AutoI)
 - <http://ist-autoi.eu/autoi/>
 - Future Internet Assembly /Management and Service-aware Networking Architectures (FIA/MANA)
 - <http://www.future-internet.eu/>
 - ICT EMANICS Network of Excellence
 - <http://www.emanics.org>



Thank you for your attention!